

GENTENG METAL
Carmelin
 RINGAN & ANTI BOCOR

GENTENG METAL

PIONIR GENTENG METAL SEJAK TAHUN 1981. TELAH TERBUKTI KUALITAS NYA

Stone Chips :

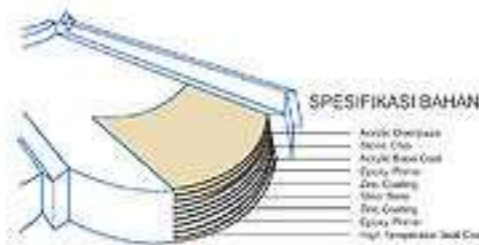

GENTENG METAL
Carmelin
 RINGAN & ANTI BOCOR

Petunjuk TEKNIS

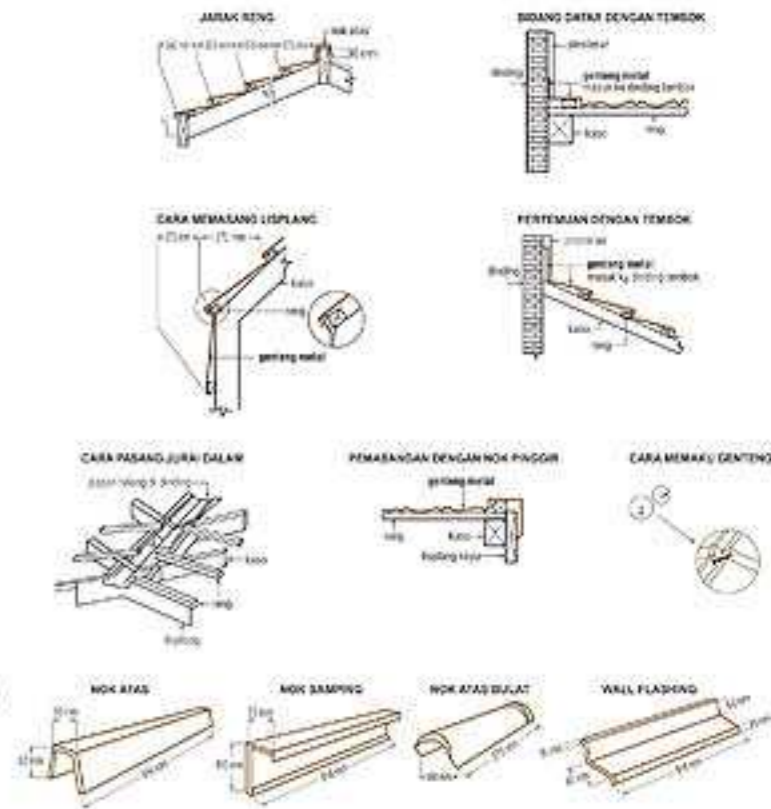

Dimensi GENTENG

Panjang efektif :	750 mm	Luas efektif :	0,615 m ²
Lebar efektif :	820 mm	Berat per m ² :	4,37 kg/m ²
Toleransi :	± 5 mm	Jumlah lembar per m ² :	1,62 lbr/m ²



website: www.Rainbow-Roof.co.id

THE HISTORY OF
Camelin
RESEARCH GROUP







2008-2010

Mr. L. J. ...

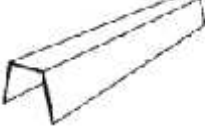

Mr. L. J. ...



GENTENG TYPE 2 X 4	DIMENSI PRODUK	STONE / BATUAN
	Panjang : 75 Cm Lebar : 82 Cm 1 m ² : 1,62 Lbr Jarak Reng : 37,5 Cm	Rp 61,000 /Lbr
	NOK BULAT STANDAR (NBS)	
	Panjang : 37,5 Cm Diameter : 12 Cm	Rp 27,000 /Lbr
	NOK BULAT BESAR (NBB)	
	Panjang : 91,4 Cm Diameter : 14 Cm	Rp 48,000 /Lbr
	NOK ATAS STANDAR (NAS)	
	Panjang : 91,4 Cm Lebar : 5 Cm Tinggi : 6,5 Cm	Rp 36,000 /Lbr
	NOK PINGGIR (NPG)	
	Panjang : 91,4 Cm Lebar : 7 Cm Tinggi : 11 Cm	Rp 40,000 /Lbr
	WALL FLASHING (WFS)	
	Panjang : 91,4 Cm Lebar : 10 Cm Tinggi : 6 Cm	Rp 38,500 /Lbr
	FLAT SHEET (FST)	
	Panjang : 200 Cm Lebar : 45,7 Cm	Rp 206,000 /Lbr

Catatan:

- * Harga dapat berubah sewaktu-waktu tanpa pemberitahuan sebelumnya
- * Paku anti karat Rp. 20.000,-/Kg(30M² s/d 35 M²)
- * Pengiriman di luar DKI akan dikenakan biaya tambahan
- * Barang yang sudah di beli tidak dapat di retur
- * Pembatalan di atas 24 jam di kenakan biaya 10%
- * Harga tersebut di atas belum termasuk PPN 10%



www.jayawan.com

Pionir Genteng Metal Sejak Tahun 1981 Telah Terbukti Kualitasnya